

## STANDARD MENHIR POST

**E9B051-** -  
 base number      Color      Finish  
                          Temperature      Options

- To build a product code in our configurator select the specify button on the base model # product page
- To build a manual product code on this datasheet choose from the options listed below in blue font and add the suffix to the base model #

### GENERAL

Series: Menhir  
 Subseries: Standard Menhir  
 Brand: Platek  
 Division: Exterior  
 Mounting Type: Post  
 Mounting Location: Above Ground  
 Subcategory: Bollard - Mini

### PHYSICAL

Shape: Cylinder  
 Diameter (mm): 200  
 Diameter (in): 7 7/8  
 Height (mm): 200  
 Height (in): 7 7/8  
 Light Distribution: Direct  
 Screws: A4 stainless steel  
 Diffuser: Clear tempered glass  
 Fixture Finish: BLK / WHI / GRY / COR / ANT / BRZ  
 Fixture Material: Aluminum  
 Cable Details: 8-13mm cable allowed

### ELECTRICAL

Lamp Type: LED  
 Input Wattage (W): 15.5  
 Total Output Wattage (W): 12  
 Dimming: Non-Dimming / Phase Dimming (120vac Only)  
 Driver Included: Yes  
 Driver Location: Integrated  
 Driver Type: Constant Current - 120 / 277Vac  
 Driver Class: Class 2  
 Input Voltage (V): 120 - 277  
 Constant Current (MA): 350  
 Upon Request: (Not included - see components [IP65 or higher enclosure to be supplied by others]): Remote: 0-10Vdc dimming

### LED

Color Temperature (°K): 3000 / 4000  
 Max. Delivered Lumen (lm): 915 / 955  
 Nominal Lumen (lm): 1740 / 1810  
 CRI: >80 CRI  
 Lamp Life (hrs): 60000

### OPTICAL

Optic°: 2 Openings

### RATINGS AND CERTIFICATIONS

Certified By: Certified for North American Standards  
 IP rating: IP65  
 IK Rating: IK08  
 Bug Rating: B1 U3 G1



## STANDARD MENHIR POST

E9B051-

PROJECT \_\_\_\_\_

TYPE \_\_\_\_\_

SPECIFIER \_\_\_\_\_

QUANTITY \_\_\_\_\_

DATE \_\_\_\_\_



## MICRO MENHIR POST

### E9B163-

base number                              
 Color                      Finish  
 Temperature              Options

- To build a product code in our configurator select the specify button on the base model # product page
- To build a manual product code on this datasheet choose from the options listed below in blue font and add the suffix to the base model #

#### GENERAL

Series: Menhir  
 Subseries: Micro Menhir  
 Brand: Platek  
 Division: Exterior  
 Mounting Type: Post  
 Mounting Location: Above Ground  
 Subcategory: Marker

#### PHYSICAL

Shape: Cylinder  
 Diameter (mm): 115  
 Diameter (in): 4 1/2  
 Height (mm): 150  
 Height (in): 5 7/8  
 Light Distribution: Direct  
 Screws: A4 stainless steel  
 Diffuser: Transparent Methacrylate  
 Fixture Finish: [BLK](#) / [WHI](#) / [GRY](#) / [COR](#) / [ANT](#) / [BRZ](#)  
 Fixture Material: Aluminum

#### ELECTRICAL

Lamp Type: LED  
 Input Wattage (W): 9.6  
 Total Output Wattage (W): 8.3  
 Dimming: Non-Dimmable  
 Driver Included: No  
 Driver Location: Remote  
 Driver Type: Constant Current - Universal  
 Driver Class: Class 2  
 Input Voltage (V): 120 - 277  
 Constant Current (MA): 250  
 Constant Voltage (V): 34

#### LED

Color Temperature (°K): [3000](#) / [4000](#)  
 Max. Delivered Lumen (lm): 255 / 265  
 Nominal Lumen (lm): 900 / 935  
 CRI: >80 CRI  
 Lamp Life (hrs): 60000

#### OPTICAL

Optic°: 1 Opening

#### RATINGS AND CERTIFICATIONS

Certified By: Certified for North American Standards  
 IP rating: IP65  
 IK Rating: IK10  
 Bug Rating: B0 U0 G1

PROJECT
TYPE
SPECIFIER
QUANTITY
DATE



115mm 4 1/2"

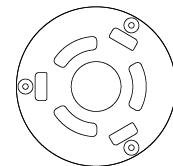

115mm 4 1/2"



## MICRO MENHIR POST

E9B163-

PROJECT

TYPE

SPECIFIER

QUANTITY

DATE



## MICRO MENHIR POST

### E9B167-

base number                          
 Color            Finish  
 Temperature    Options

- To build a product code in our configurator select the specify button on the base model # product page
- To build a manual product code on this datasheet choose from the options listed below in blue font and add the suffix to the base model #

#### GENERAL

Series: Menhir  
 Subseries: Micro Menhir  
 Brand: Platek  
 Division: Exterior  
 Mounting Type: Post  
 Mounting Location: Above Ground  
 Subcategory: Bollard

#### PHYSICAL

Shape: Cylinder  
 Diameter (mm): 115  
 Diameter (in): 4 1/2  
 Height (mm): 500  
 Height (in): 19 11/16  
 Light Distribution: Direct  
 Screws: A4 stainless steel  
 Diffuser: Transparent Methacrylate  
 Fixture Finish: [BLK](#) / [WHI](#) / [GRY](#) / [COR](#) / [ANT](#) / [BRZ](#)  
 Fixture Material: Aluminum

#### ELECTRICAL

Lamp Type: LED  
 Input Wattage (W): 16  
 Total Output Wattage (W): 15  
 Dimming: Electronic Low Voltage Dimming  
 Input Voltage (V): 120Vac Direct Line

#### LED

[Color Temperature \(°K\): 3000 / 4000](#)  
 Max. Delivered Lumen (lm): 340 / 355  
 Nominal Lumen (lm): 1350 / 1405  
 CRI: >80 CRI  
 Lamp Life (hrs): 60000

#### OPTICAL

Optic°: 1 Opening

#### RATINGS AND CERTIFICATIONS

Certified By: Certified for North American Standards  
 IP rating: IP65  
 IK Rating: IK10  
 Bug Rating: B1 U0 G1

PROJECT
TYPE
SPECIFIER
QUANTITY
DATE



115mm 4 1/2"

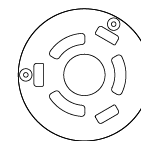
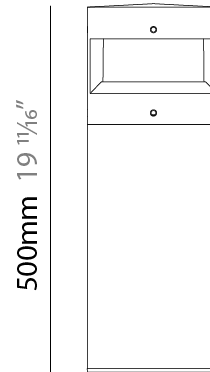

115mm 4 1/2"



## MICRO MENHIR POST

E9B167-

PROJECT

TYPE

SPECIFIER

QUANTITY

DATE



## MICRO MENHIR POST

### E9B168-

base number                                      
 Color                      Finish  
 Temperature              Options

- To build a product code in our configurator select the specify button on the base model # product page
- To build a manual product code on this datasheet choose from the options listed below in blue font and add the suffix to the base model #

#### GENERAL

Series: Menhir  
 Subseries: Micro Menhir  
 Brand: Platek  
 Division: Exterior  
 Mounting Type: Post  
 Mounting Location: Above Ground  
 Subcategory: Bollard

#### PHYSICAL

Shape: Cylinder  
 Diameter (mm): 115  
 Diameter (in): 4 1/2  
 Height (mm): 500  
 Height (in): 19 11/16  
 Light Distribution: Direct  
 Screws: A4 stainless steel  
 Diffuser: Transparent Methacrylate  
 Fixture Finish: [BLK](#) / [WHI](#) / [GRY](#) / [COR](#) / [ANT](#) / [BRZ](#)  
 Fixture Material: Aluminum

#### ELECTRICAL

Lamp Type: LED  
 Input Wattage (W): 16  
 Total Output Wattage (W): 15  
 Dimming: Electronic Low Voltage Dimming  
 Input Voltage (V): 120Vac Direct Line

#### LED

Color Temperature (°K): [3000](#) / [4000](#)  
 Max. Delivered Lumen (lm): 665 / 690  
 Nominal Lumen (lm): 1350 / 1405  
 CRI: >80 CRI  
 Lamp Life (hrs): 60000

#### OPTICAL

Optic°: 2 Openings

#### RATINGS AND CERTIFICATIONS

Certified By: Certified for North American Standards  
 IP rating: IP65  
 IK Rating: IK10

PROJECT
TYPE
SPECIFIER
QUANTITY
DATE



115mm 4 1/2"

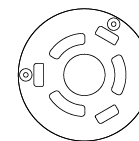
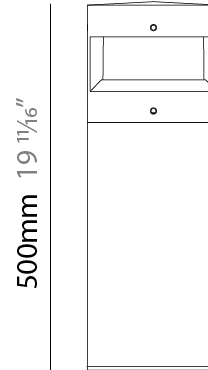

115mm 4 1/2"



## MICRO MENHIR POST

E9B168-

PROJECT

TYPE

SPECIFIER

QUANTITY

DATE

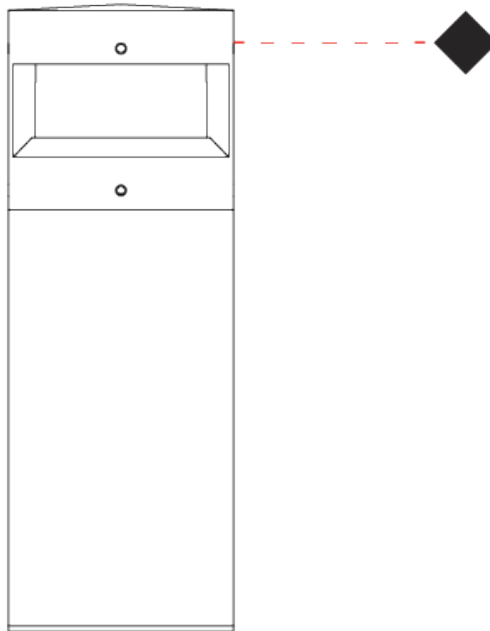



## MICRO MENHIR POST

**E9B171-** -

base number                                                  
 Color                      Finish  
 Temperature              Options

- To build a product code in our configurator select the specify button on the base model # product page
- To build a manual product code on this datasheet choose from the options listed below in blue font and add the suffix to the base model #

### GENERAL

Series: Menhir  
 Subseries: Micro Menhir  
 Brand: Platek  
 Division: Exterior  
 Mounting Type: Post  
 Mounting Location: Above Ground  
 Subcategory: Bollard

### PHYSICAL

Shape: Cylinder  
 Diameter (mm): 115  
 Diameter (in): 4 ½  
 Height (mm): 800  
 Height (in): 31 ½  
 Light Distribution: Direct  
 Screws: A4 stainless steel  
 Diffuser: Transparent Methacrylate  
 Fixture Finish: [BLK](#) / [WHI](#) / [GRY](#) / [COR](#) / [ANT](#) / [BRZ](#)  
 Fixture Material: Aluminum

### ELECTRICAL

Lamp Type: LED  
 Input Wattage (W): 16  
 Total Output Wattage (W): 15  
 Dimming: Electronic Low Voltage Dimming  
 Input Voltage (V): 120Vac Direct Line

### LED

Color Temperature (°K): [3000](#) / [4000](#)  
 Max. Delivered Lumen (lm): 340 / 355  
 Nominal Lumen (lm): 1350 / 1405  
 CRI: >80 CRI  
 Lamp Life (hrs): 60000

### OPTICAL

Optic°: 1 Opening

### RATINGS AND CERTIFICATIONS

Certified By: Certified for North American Standards  
 IP rating: IP65  
 IK Rating: IK10

PROJECT \_\_\_\_\_  
 TYPE \_\_\_\_\_  
 SPECIFIER \_\_\_\_\_  
 QUANTITY \_\_\_\_\_  
 DATE \_\_\_\_\_

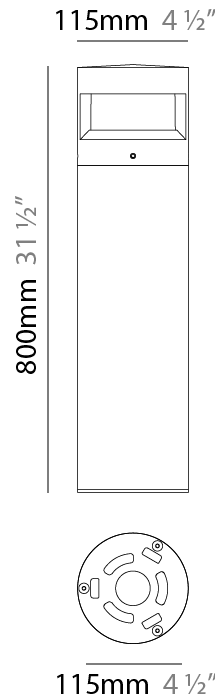

## MICRO MENHIR POST

E9B171-

PROJECT

TYPE

SPECIFIER

QUANTITY

DATE



## MICRO MENHIR POST

**E9B172-** -

base number                              
 Color                      Finish  
 Temperature              Options

- To build a product code in our configurator select the specify button on the base model # product page
- To build a manual product code on this datasheet choose from the options listed below in blue font and add the suffix to the base model #

### GENERAL

Series: Menhir  
 Subseries: Micro Menhir  
 Brand: Platek  
 Division: Exterior  
 Mounting Type: Post  
 Mounting Location: Above Ground  
 Subcategory: Bollard

### PHYSICAL

Shape: Cylinder  
 Diameter (mm): 115  
 Diameter (in): 4 ½  
 Height (mm): 800  
 Height (in): 31 ½  
 Light Distribution: Direct  
 Screws: A4 stainless steel  
 Diffuser: Transparent Methacrylate  
 Fixture Finish: [BLK](#) / [WHI](#) / [GRY](#) / [COR](#) / [ANT](#) / [BRZ](#)  
 Fixture Material: Aluminum

### ELECTRICAL

Lamp Type: LED  
 Input Wattage (W): 16  
 Total Output Wattage (W): 15  
 Dimming: Electronic Low Voltage Dimming  
 Input Voltage (V): 120Vac Direct Line

### LED

Color Temperature (°K): [3000](#) / [4000](#)  
 Max. Delivered Lumen (lm): 665 / 690  
 Nominal Lumen (lm): 1350 / 1405  
 CRI: >80 CRI  
 Lamp Life (hrs): 60000

### OPTICAL

Optic°: 2 Openings

### RATINGS AND CERTIFICATIONS

Certified By: Certified for North American Standards  
 IP rating: IP65  
 IK Rating: IK10

PROJECT
TYPE
SPECIFIER
QUANTITY
DATE



## MICRO MENHIR POST

E9B172-

PROJECT

TYPE

SPECIFIER

QUANTITY

DATE



## STANDARD MENHIR POST

### E9B258-

base number    Color    Finish  
 Temperature    Options

- To build a product code in our configurator select the specify button on the base model # product page
- To build a manual product code on this datasheet choose from the options listed below in blue font and add the suffix to the base model #

#### GENERAL

Series: Menhir  
 Subseries: Standard Menhir  
 Brand: Platek  
 Division: Exterior  
 Mounting Type: Post  
 Mounting Location: Above Ground  
 Subcategory: Marker

#### PHYSICAL

Shape: Cylinder  
 Diameter (mm): 200  
 Diameter (in): 7 7/8  
 Height (mm): 200  
 Height (in): 7 7/8  
 Light Distribution: Direct  
 Screws: A4 stainless steel  
 Diffuser: Clear tempered glass  
 Fixture Finish: BLK / WHI / GRY / COR / ANT / BRZ  
 Fixture Material: Aluminum  
 Cable Details: 8-13mm cable allowed

#### ELECTRICAL

Lamp Type: LED  
 Input Wattage (W): 15.5  
 Total Output Wattage (W): 12  
 Dimming: Non-Dimming / Phase Dimming (120vac Only)  
 Driver Included: Yes  
 Driver Location: Integrated  
 Driver Type: Constant Current - Universal  
 Driver Class: Class 2  
 Input Voltage (V): 120 - 277  
 Constant Current (MA): 350  
 Upon Request: (Not included - see components [IP65 or higher enclosure to be supplied by others]) Remote : 0-10Vdc dimming

#### LED

Number of LEDs: 1  
 Color Temperature (°K): 3000 / 4000  
 Max. Delivered Lumen (lm): 510 / 530  
 Nominal Lumen (lm): 1740 / 1810  
 CRI: >80 CRI  
 Lamp Life (hrs): 60000

#### OPTICAL

Optic°: 1 Opening

#### RATINGS AND CERTIFICATIONS

Certified By: Certified for North American Standards  
 IP rating: IP65  
 IK Rating: IK08

PROJECT
TYPE
SPECIFIER
QUANTITY
DATE

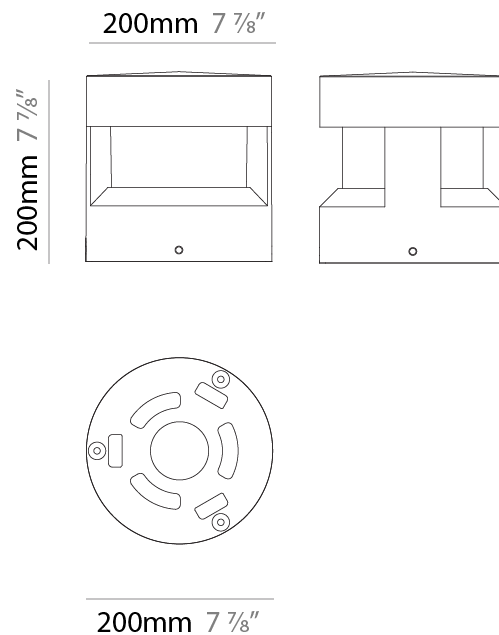
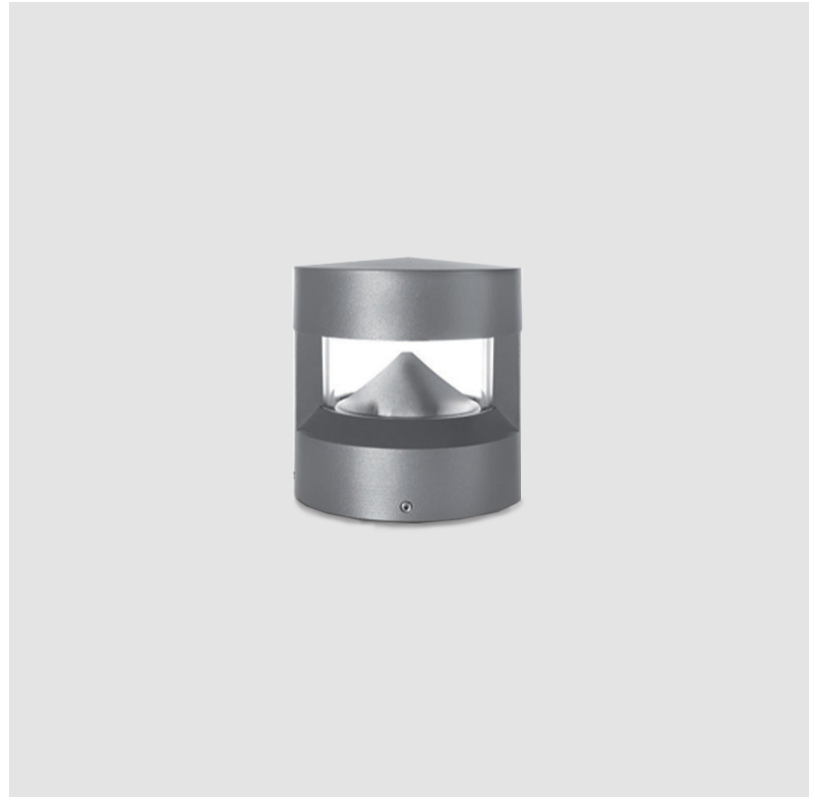

## STANDARD MENHIR POST

E9B258-

PROJECT \_\_\_\_\_

TYPE \_\_\_\_\_

SPECIFIER \_\_\_\_\_

QUANTITY \_\_\_\_\_

DATE \_\_\_\_\_

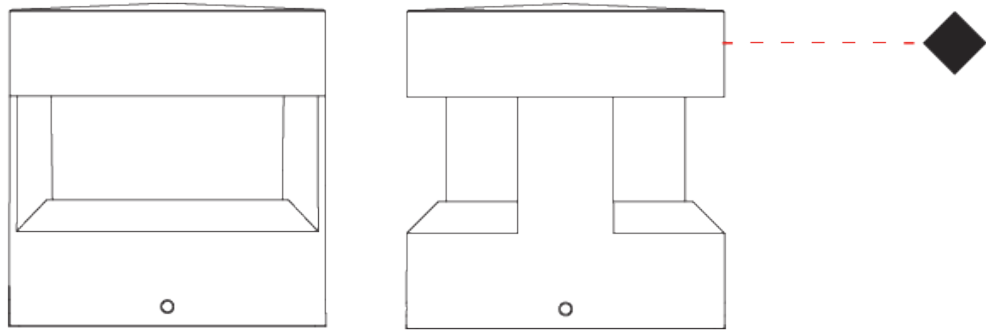

PROJECT \_\_\_\_\_

TYPE \_\_\_\_\_

SPECIFIER \_\_\_\_\_

QUANTITY \_\_\_\_\_

DATE \_\_\_\_\_

#### Fixture Finish

Black - BLK



White - WHI



Gray - GRY



Corten - COR



Anthracite - ANT



Bronze - BRZ



**Digital:** Not all screens are calibrated the same, and therefore, colors will appear differently between screens.

**Physical:** When texture is involved, there will be variations in color, character and tone within a product series and between product families.



### LEGEND

	floor-mounted		pivotal		special LED (upon request) RGB, RGBW, tunable, gold+, meat+, art+, fashion+
	wall and ceiling: recessed and surface mounted		rotating		warm dim / natural dimming LED
	ceiling-mounted and wall-mounted		illuminate tilted		rechargeable battery powered
	wall-mounted		color of suspension cable		fixture with natural vivid LED (upon request)
	omni-directional light distribution		length of suspension cable		color rendering index
	direct light distribution		reflector degree selection		color temperature
	direct/indirect light distribution		super spot		lumen (luminous flux)
	indirect light distribution		lens		efficacy (lumens per watt)
	asymmetric light distribution		lens pack		Unified Glare Rating (UGR) range from 5-40
	aura light distribution		shine ring		marine grade (AISI 316 stainless steel)
	round wall or ceiling cut-out		integrated shine ring with diffuser		walk on
	square wall or ceiling cut-out		free individual colors 01-29		drive on
	the supplied jig specifies the cutout dimensions		individual colors: 00 (free of charge), 01-25 (extra charge)		Dark Sky Compliance
	minimum distance (meters) lamp - object		luminaire part to be colored (F1)		Americans with Disabilities Act (less than 4" off the wall located between 27"-84" from floor)
	recessed depth		luminaire part to be colored (F2)		lamp protected against explosion
	ceiling thickness in mm		luminaire part to be colored (F3)		blown glass using traditional methods by master glass blower
	ceiling thickness selection		luminaire part to be colored (F4)		acoustic material
	dimmable DP (phase), DV (0-10V), DD (dali), DS (step-dim)		luminaire part to be colored (F5)		protection class I, protection insulation
	included or excluded LED driver/transformer/control gear		color of 3-circuit adaptor		protection class II, protection insulation
	separately switchable		indirect diffuser		ETL Certified to UL and CSA Standards
	sensor		direct diffuser		UL Certified to UL and CSA Standards
	remote control		ball-proof (upon request)		CSA Certified to UL and CSA Standards
	available upon request		accessory		Certified for North American Standards

### IP RATING

	protected against ingress of solid bodies greater than 12.5mm (finger)
	protected against ingress of solid bodies greater than 2.5mm protected against sprays of water up to 60 degrees from the vertical (rain)
	protected against ingress of solid bodies greater than 1mm (wire) no protection against the ingress of moisture
	protected against ingress of solid bodies greater than 1mm (wire) protected against sprays of water up to 60 degrees from the vertical (rain)
	protected against ingress of solid bodies greater than 1mm (wire) protected against water splashed from all directions
	protected against limited ingress of dust (wet rooms/covered outdoor areas) protected against water splashed from all directions
	protected against ingress of dust protected against jets of water
	protected against ingress of dust protected against powerful jets of water or heavy seas
	protected against ingress of dust protected against immersion of water between 15cm - 1m for 30 minutes
	protected against ingress of dust protected against immersion of water under pressure for long periods

### IK RATING

	protected against 0.14 joules impact (equivalent to 0.25kg mass dropped from 56mm above the surface)
	protected against 0.2 joules impact (equivalent to 0.25kg mass dropped from 80mm above the surface)
	protected against 0.35 joules impact (equivalent to 0.25kg mass dropped from 140mm above the surface)
	protected against 0.5 joules impact (equivalent to 0.25kg mass dropped from 200mm above the surface)
	protected against 0.7 joules impact (equivalent to 0.25kg mass dropped from 280mm above the surface)
	protected against 1 joules impact (equivalent to 0.25kg mass dropped from 400mm above the surface)
	protected against 2 joules impact (equivalent to 0.5kg mass dropped from 400mm above the surface)
	protected against 5 joules impact (equivalent to 1.7kg mass dropped from 300mm above the surface)
	protected against 10 joules impact (equivalent to 5.0kg mass dropped from 200mm above the surface)
	protected against 20 joules impact (equivalent to 5.0kg mass dropped from 400mm above the surface)